









CONTENITORI E ANTINCENDIO



CONTENITORI E ANTINCENDIO		listino
CONTENITORI PE		1
CONTENITORI INDUSTRIALI		8
CONTENITORI INDUSTRIALI SERIE COLOR GRIGIO		12
LASTRE "SAFE CRASH" PER CASSETTE ANTINCENDIO		13
ACCESSORI ANTINCENDIO		14









CONTENITORI PE IN POLIETILENE BIANCO ALIMENTARE		
COD.ART.	DESCRIZIONE	PREZZO CAD
98	Bottiglia pol. grigio scuro BS.cc.250	€ 0,83
		
99	Bottiglia pol. grigio scuro BS cc.500	€ 0,97
		
100	Bottiglia pol. grigio scuro BS. cc.1000	€ 1,67
		
103	Bottiglia rettangolare pol. bianco cc.100	€ 0,40
		
104	Bottiglia pol. bianco BL. cc.250	€ 0,71
		
105	Bottiglia pol. bianco BL. cc.500	€ 0,77
		
106	Bottiglia pol. bianco BL. cc.1000	€ 1,28
		
107	Bottiglia pol. bianco BL. cc.2000	€ 2,31
		
		+IVA

CONTENITORI IN PE







CONTENITORI PE IN POLIETILENE BIANCO ALIMENTARE		
COD.ART.	DESCRIZIONE	PREZZO CAD
108	Bottiglia pol. bianco BS. cc.250	€ 0,71
		
109	Bottiglia pol. bianco BS. cc.500	€ 0,77
		
110	Bottiglia pol. bianco BS. cc.1000	€ 1,28
		
111	Bottiglia pol. bianco BS. cc.2000	€ 2,31
		
112	Canestro pol. bianco lt.1	€ 1,42
		
113	Canestro pol. bianco lt.2	€ 1,67
		
114	Canestro pol. bianco lt.3	€ 2,06
		
115	Canestro pol. bianco lt.5	€ 2,40
		
		+IVA

CONTENITORI IN PE

CONTENITORI PE IN POLIETILENE BIANCO ALIMENTARE		
COD.ART.	DESCRIZIONE	PREZZO CAD
116	Canestro pol. bianco lt.10	€ 3,85
		
117	Canestro pol. bianco lt.15	€ 5,26
		
118	Canestro pol. bianco lt.20	€ 5,99
		
119	Canestro pol. bianco lt.25	€ 7,13
		
120	Canestro pol. bianco lt.20 con rubinetto	€ 10,26
		
121	Caraffe graduate polipropilene bianco lt.1	€ 1,69
		
122	Caraffe graduate polipropilene bianco lt.2	€ 2,64
		
123	Caraffe graduate polipropilene bianco lt.3	€ 3,34
		
		+IVA

CONTENITORI PE IN POLIETILENE BIANCO ALIMENTARE		
COD.ART.	DESCRIZIONE	PREZZO CAD
125	Caraffe graduate polipropilene bianco lt.5	€ 4,87
		
127	Vaporizzatore cc.500	€ 3,21
		
128	Bottiglia cc. 500 -ricambio-	€ 0,68
		
134	Dosatore pol.grigio scuro cc.50	€ 0,77
		
135	Dosatore pol.bianco cc.50	€ 0,64
		
136	Dosatore pol.bianco cc.100	€ 1,22
		
138	Dosatore pol.bianco cc.150	€ 1,28
		
139	Dosatore pol.bianco cc.200	€ 1,39
		
		+IVA



CONTENITORI IN PE



CONTENITORI PE IN POLIETILENE BIANCO ALIMENTARE		
COD.ART.	DESCRIZIONE	PREZZO CAD
140	Dosatore pol.bianco cc.500	€ 1,73
		
141	Fusto pol.bianco BL.con coperchio lt.20	€ 11,58
		
142	Fusto pol.bianco BL.con coperchio lt.30	€ 13,24
		
143	Fusto pol.bianco cilindrico 2 imbocchi lt.50	€ 16,35
		
144	Fustino cilindrico pol.bianco lt.5	€ 1,92
		
145	Fustino cilindrico pol.bianco lt.10	€ 3,67
		
		+IVA

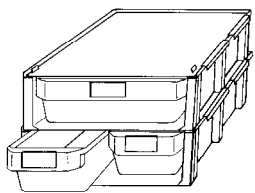
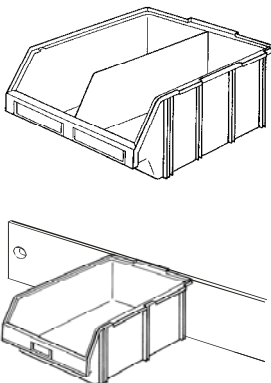
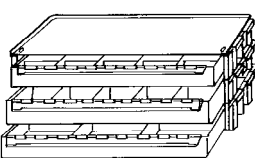
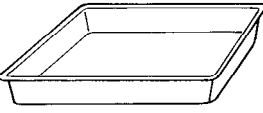
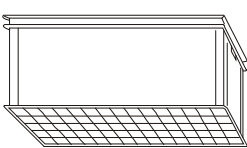

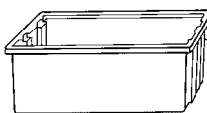

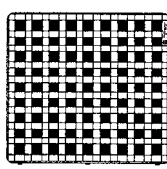
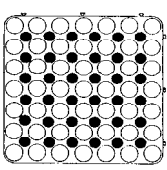
CONTENITORI PE IN POLIETILENE BIANCO ALIMENTARE		
COD.ART.	DESCRIZIONE	PREZZO CAD
	confezione da 1000 pezzi	
146	Regolatore di flusso bianco viscosità da 1 a 4	€ 37,10
		
147	Regolatore di flusso giallo viscosità da 4 a 8	€ 11,40
		
148	Regolatore di flusso blu viscosità da 5 a 10	€ 28,85
		
		+IVA

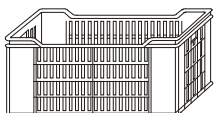
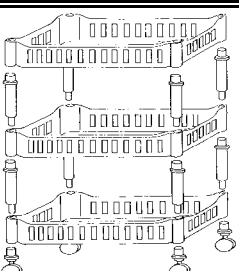
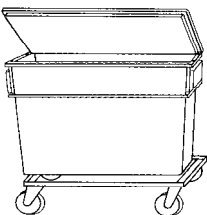
CONTENITORI IN PE

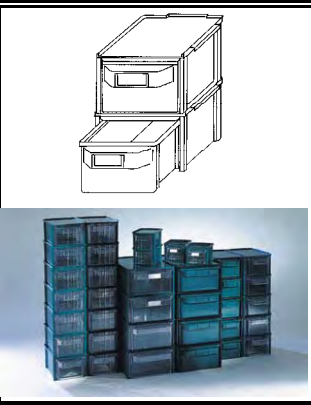
CONTENITORI			
COD. ART.		DESCRIZIONE	PREZZO CAD
1004		Contenitore ALFA MEC 12-40	€ 4,31
1009		Separatore per ALFA MEC 12	€ 0,79
1014		Contenitore ALFA MEC 24-40	€ 6,93
1019		Separatore per ALFA MEC 24	€ 1,16
1050		Cassettera ALFA MEC 12-40	€ 25,46
1060		Cassettera ALFA MEC 24-40	€ 22,10
1061		Coperchio ALFA MEC	€ 9,14
1101		Contenitore verde ALFA 1	€ 0,95
1102		Contenitore verde ALFA 2	€ 1,89
1103		Contenitore verde ALFA 3	€ 3,31
1104		Contenitore verde ALFA 4	€ 7,30
1105		Contenitore verde ALFA 5	€ 13,60
1106		Contenitore verde ALFA 6	€ 25,94
1107			€ 34,07
1155		Contenitore verde ALFA 5 bis	€ 19,32
1166		Contenitore verde ALFA 6 bis	€ 34,65
1177		Contenitore verde ALFA 7 bis	€ 44,31
		a richiesta per alfa 2-3-4-5 sono disponibili nei colori: giallo, blu, rosso	
1201		Cassetto e fascia BETA B	€ 19,01
1202		Coperchio per cassetto BETA B	€ 10,50
1228		Bacinella verde BETA 4	€ 2,78
1229		Bacinella verde BETA 6	€ 2,52
1230		Bacinella verde BETA 10	€ 1,58
1231		Bacinella verde BETA 20	€ 1,68
1301		Bacinella antiac. bianca GAMMA 1	€ 2,57
1302		Bacinella antiac. bianca GAMMA 2	€ 4,88
1303		Bacinella antiac. bianca GAMMA 3	€ 7,30
1304		Bacinella antiac. bianca GAMMA 4	€ 12,92
1305		Bacinella antiac. bianca GAMMA 5	€ 23,36
1306		Bacinella antiac. bianca GAMMA 6	€ 34,60
1401		Contenitore verde DELTA lt. 20	€ 15,23
1402		Contenitore verde DELTA lt. 21	€ 15,23
1403		Contenitore verde DELTA lt. 30	€ 20,32
1404		Contenitore verde DELTA lt. 60	€ 34,44
			+IVA

CONTENITORI			
COD. ART.	DESCRIZIONE	PREZZO CAD	
1408	 ALIMENTARE	Contenitore grigio TAU 27	€ 13,34
1409		Contenitore grigio TAU 40	€ 18,85
1410		Contenitore grigio TAU 70	€ 22,52
1411/27		Coperchio grigio per TAU 27	€ 9,14
1411/40		Coperchio grigio per TAU 40	€ 11,92
1413		Cop. nero sigill. DELTA MEC 12 e DELTA 21	€ 7,61
1414		Coperchio nero per DELTA MEC 12	€ 5,72
1415		Coperchio nero per DELTA MEC 25-50	€ 9,71
1416		Coperchio nero per lt.20	€ 11,45
1417		Coperchio nero a slitta per DELTA MEC 25-50	€ 13,55
1418		Coperchio nero per lt.30	€ 15,23
1419		Coperchio nero per lt.60	€ 17,64
1420		Coperchio nero per lt.70 OMIKRON	€ 9,14
1421		Coperchio nero per lt.100 OMIKRON	€ 10,61
1422		Coperchio nero per lt.200 OMIKRON	€ 18,22
1451		Carrello per DELTA lt.20	€ 65,10
1452		Carrello per DELTA lt.21	€ 65,10
1453		Carrello per DELTA lt.30	€ 65,10
1454		Carrello per DELTA lt.60	€ 98,70
1501		Pedana componibile EPSILON nero	€ 7,98
1502		Pedana componibile EPSILON verde	€ 7,98
1503		Pedana componibile EPSILON legno	€ 7,98
1520		Pedana componibile SIGMA 50 verde	€ 19,74
			+IVA

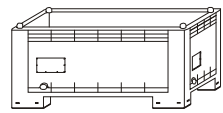
CONTENITORI			
COD. ART.		DESCRIZIONE	PREZZO CAD
1726 1728		Cesta forata alimentare JOTA gialla lt.40 Cesta forata JOTA fumo lt. 40	€ 21,84 € 18,22
1801 1810 1812		Cestello forato LAMBDA giallo alimentare Ruota per cestello LAMBDA Distanziali neri per LAMBDA	€ 12,13 € 4,99 € 1,31
1870 1871 1872 1873 1874 1879 1902 1903 1904 1908		Contenitore grigio OMIKRON lt.6 Coperchio nero a slitta sigill. OMIKRON lt.6 Carrello per OMIKRON lt.70 Aletta per OMIKRON lt.70 Contenitore verde OMIKRON lt.70 Coperchio verde OMIKRON lt.70 Carrello per OMIKRON lt.100 Aletta per OMIKRON lt.100 Contenitore verde OMIKRON lt.100 Coperchio verde OMIKRON lt.100	€ 4,99 € 4,99 € 101,85 € 2,57 € 34,86 € 10,71 € 108,15 € 2,57 € 46,41 € 14,81
2102 2103 2104 2107 3016		Carrello per OMIKRON lt.200 Aletta per OMIKRON lt.200 Contenitore verde OMIKRON lt.200 Coperchio verde OMIKRON lt.200 Contenitore nero OMIKRON lt.200	€ 112,35 € 5,09 € 84,11 € 23,73 € 63,95
2113 2114 2115 2131 2132 2133 2134 2135 2136 2137 2138 2139		Cassettiera RHO KAPPA 3 Tr.+ verde Cassettiera RHO KAPPA 4 Tr.+ verde Cassettiera RHO KAPPA 5 Tr.+ verde Coperchio per KAPPA 3 Coperchio per KAPPA 4 Coperchio per KAPPA 5 Cassettiera RHO KAPPA 3 verde+nero Cassettiera RHO KAPPA 4 verde+nero Cassettiera RHO KAPPA 5 verde+nero Cassettiera RHO KAPPA 3 Tr+nero Cassettiera RHO KAPPA 4 Tr+nero Cassettiera RHO KAPPA 5 Tr+nero	€ 6,98 € 20,16 € 36,28 € 1,68 € 3,20 € 5,72 € 5,72 € 16,17 € 28,09 € 6,30 € 18,01 € 31,87
			+IVA

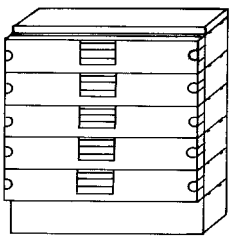
CONTENITORI			
COD. ART.		DESCRIZIONE	PREZZO CAD
2200		PALLET NERI PER CARICO MEDIO	
2201		Pallet MY-A 1200X800X140	€ 32,66
2220		Pallet MY-A 1200x1000X140	€ 40,85
2221		Pallet MY-A-BIS 1200x800X173 con bordo	€ 49,67
		Pallet MY-A-BIS 1200X1000X173 con bordo	€ 57,33
2260A		Cargopallet lt.300 PLUS grigio alimentare	€ 114,45
2260		Cargopallet lt.300 PLUS grigio industriale	€ 100,80
2261A		Cargopallet lt.300 PLUS grigio alimentare +ruote	€ 193,20
2261		Cargopallet lt.300 PLUS grigio industriale +ruote	€ 179,55
2262A		Coperchio per cargopallet lt.300 PLUS alimentare	€ 38,85
2262		Coperchio per cargopallet lt.300 PLUS industriale	€ 32,55
2271A		Cargopallet lt.600 PLUS grigio alimentare	€ 194,25
2271		Cargopallet lt.600 PLUS grigio industriale	€ 165,90
2272A		Cargopallet lt.600 PLUS grigio alimentare +ruote	€ 282,45
2272		Cargopallet lt.600 PLUS grigio industriale +ruote	€ 257,25
2273A		Coperchio cargopallet lt. 600 PLUS alimentare	€ 53,55
2273		Coperchio cargopallet lt. 600 PLUS industriale	€ 44,10
2274A		Cargopallet lt. 600 PLUS + 2 travette grigio alimentare	€ 214,20
2274		Cargopallet lt. 600 PLUS + 2 travette grigio industriale	€ 185,85
2275		Porta etichetta per 600 PLUS applicato	€ 10,19
2276	Rubinetto a sfera in resina per 600 PLUS	€ 70,56	
2277	Tappo a vite in resina per 600 PLUS	€ 12,71	
2901		Portacarte MERCURIO color sabbia	€ 4,73
2921		Cassetto MEMORIA 75 bianco	€ 25,52
2923		Base nera+coperchio bianco xM75	€ 29,24
2931		Cassetto MEMORIA 50 bianco	€ 20,63
2933		Base nera+coperchio bianco xM50	€ 21,63
			+IVA

CONTENITORI INDUSTRIALI

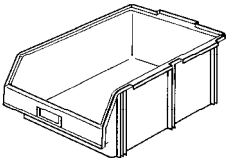
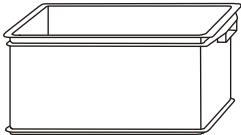
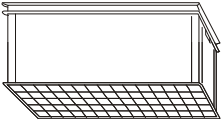
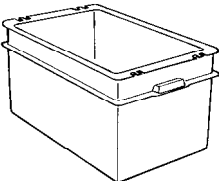
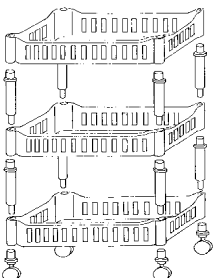
CONTENITORI SERIE COLORE GRIGIO fornitura solo a richiesta			
COD. ART.		DESCRIZIONE	PREZZO CAD
4001 4002 4003 4004 4005 4006	 COLORE GRIGIO	Contenitore ALFA 5 Contenitore ALFA 5bis Contenitore ALFA 6 Contenitore ALFA 6bis Contenitore ALFA 7 Contenitore ALFA 7bis	€ 10,92 € 15,44 € 20,84 € 27,25 € 27,25 € 35,28
4007 4008 4009 4010	 COLORE GRIGIO	Contenitore DELTA lt. 20 Contenitore DELTA lt. 21 Contenitore DELTA lt. 30 Contenitore DELTA lt. 60	€ 12,39 € 12,39 € 16,01 € 27,56
4011 4012 4013	 COLORE GRIGIO ALIMENTARE	Contenitore DELTA MEC. lt. 12 400X300 Contenitore DELTA MEC. lt. 25 600X400 Contenitore DELTA MEC. lt. 50	€ 7,88 € 13,91 € 18,90
4014 4015	 COLORE GRIGIO	Contenitore OMIKRON lt. 70 Contenitore OMIKRON lt. 100	€ 28,98 € 46,41
4016	 COLORE GRIGIO	Cestello sovrapponibile LAMBDA	€ 10,08
			+IVA

LASTRE CON PROTEZIONE U.V. SPESS. MM.3 "SAFE CRASH" PER CASSETTE PORTA MANICHETTE ANTINCENDIO		
COD. ART.	MISURA PER MODELLO MM. L'ALTEZZA E' LA SECONDA MISURA	PREZZO CAD. EURO
SAFE290X500	290X500	€ 10,19
SAFE330X530	330X530	€ 11,34
SAFE345X545	345X545	€ 11,98
SAFE370X570	370X570	€ 13,55
SAFE270X750	270X750	€ 12,79
SAFE425X575	425X575	€ 14,82
SAFE700X600	700X600	€ 23,33
SAFE450X750	450X750	€ 19,34
SAFE430X630	430X630	€ 16,10
SAFE850X850	850X850	€ 37,97
SAFE600X500	600X500	€ 17,48
SAFE570X950	570X950	€ 29,17
MISURE SPECIALI		
SAFE900X1200	900X1200	€ 67,49
SAFE1100X550	1100X550	€ 39,02
SAFE1100X730	1100X730	€ 59,27
SAFE1500X800	1500X800	€ 87,06
SAFE700X900	700X900	€ 36,53
SAFE-CRASH		
	taglio gratuito A richiesta altre dimensioni	+IVA



LASTRE "SAFE CRASH"

CASSETTE PORTAMANICHETTE E ACCESSORI		
COD. ART.	DESCRIZIONE	PREZZO CAD. EURO
PK45CR	Cassetta portamanichetta UNI45 cambio rapido rossa	€ 59,04
PK45NR	Telaio Normokit 45 rosso con lastra, gocc.e cartello	€ 39,87
PK70NR	Telaio Normokit 70 rosso con lastra, gocc.e cartello	€ 48,48
GOCC45	Gocciolatore salvamanichette UNI45 rosso	€ 3,45
BIG70	Gocciolatore salvamanichette UNI70 rosso	€ 3,71
PDABS	Cassetta porta documenti rossa in ABS vuota	€ 36,24
CC	Cassetta porta chiavi rossa completa di SAFE-CRASCH	€ 7,71
MANICHETTA/15	Manichetta tricolore UNI 45 da mt.15	€ 45,76
MANICHETTA/20	Manichetta tricolore UNI 45 da mt.20	€ 56,41
MANICHETTA/25	Manichetta tricolore UNI 45 da mt.25	€ 67,92
LANCIA/C	Lancia multieffetto UNI 45	€ 9,68
LANCIA/GN	Lancia 3 effetti leva UNI 45	€ 23,15
CTR/6T	Cassetta porta estintore 6Kg. Coperchio blindo light	€ 48,05
CTR/9T	Cassetta porta estintore 9Kg. Coperchio blindo light	€ 50,33
CTR/12T	Cassetta porta estintore 12Kg. Coperchio blindo light	€ 58,41
COP180X180	Coperta antifiamma cm.180x180	€ 37,49
COP180X120	Coperta antifiamma cm.180x120	€ 27,62
		+IVA

ACCESSORI ANTINCENDIO

L'acrilico nelle sue forme

LISTINO CONTENITORI E ANTINCENDIO

Plasting offre inoltre una vasta
gamma di altri materiali

LISTINO PMMA

LISTINO SEMILAVORATO TECNICO

LISTINO POLICARBONATO E PETG

LISTINO VISUAL, COMMUNICATION AND DESIGN



Via degli Alpini 9
20090 Segrate (Mi)
tel +39 02 28 28 384
tel +39 02 28 27 830
fax +39 02 28 42 880
www.plasting.biz
info@plasting.biz